

New range on Center, Chamfer & Engraving tools



CENTER, CHAMFER & ENGRAVING ^{NEW}





SINCE 1916

Higher performance and faster setup on engraving operations.

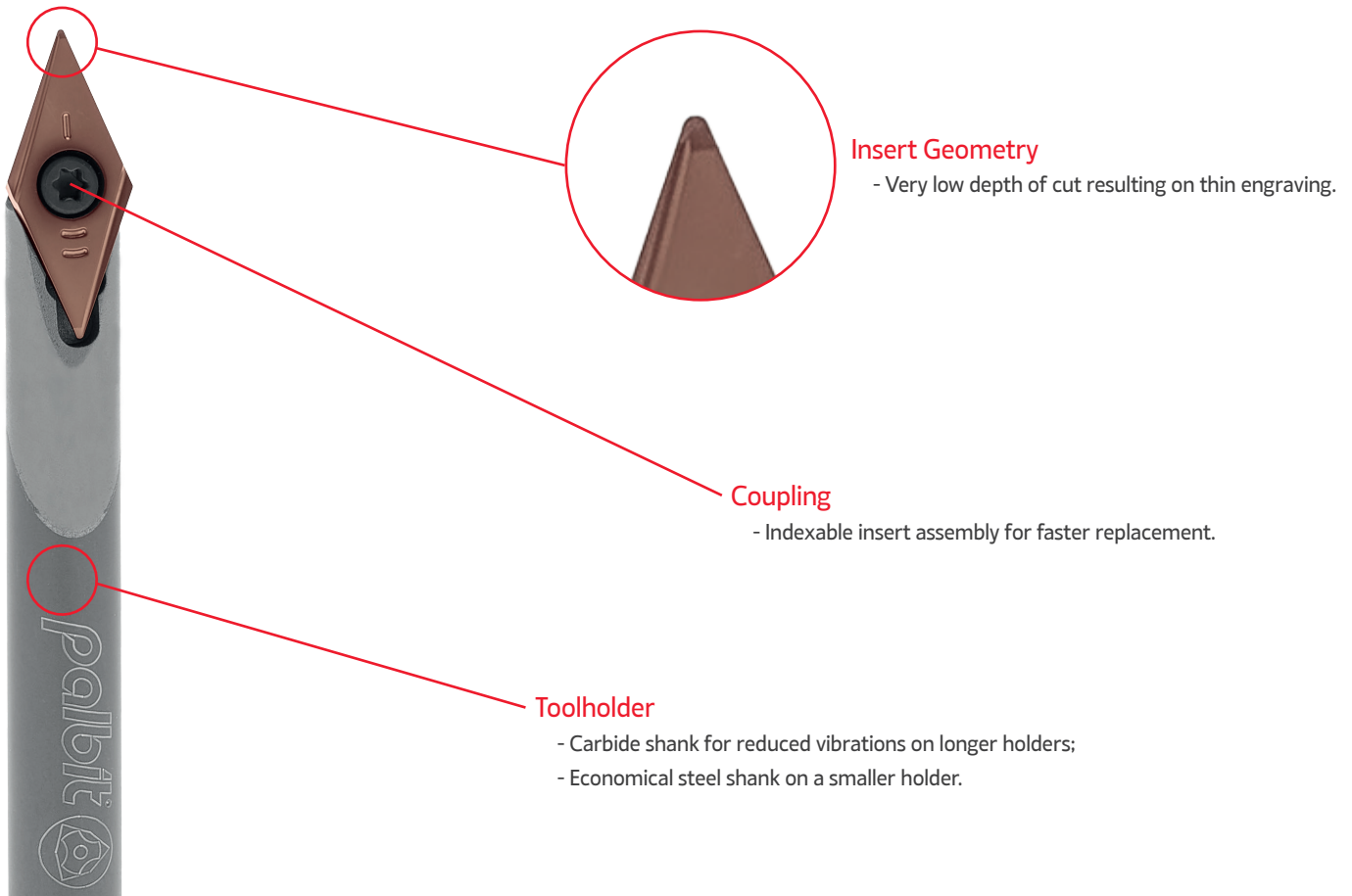
The biggest barrier in engraving is the time it takes to replace the tool. Focused on this, Palbit engineers developed a solution to overcome it. With the Indexable Line Engraving 64067, only the insert needs to be replaced. Consequently, the down time is sharply reduced, leading to a productivity boost!



KEY FEATURES | Características principais | Características principales

	Engraving 64067	Conventional Ball nose EndMill (r = 0,4mm)	Engraving Tool
Tool			
Cutting depth (a_p)	0,2 mm	0,5 mm	0,2 mm
Roughness (R_a)	0,35 μm	0,45 μ m	0,85 μ m
Setup time	Low	High	High
Tool life	Long	Short	Short

Note: Data obtained from trials with tool steel and hardness 210 HB

VPGT-45LM

P M S

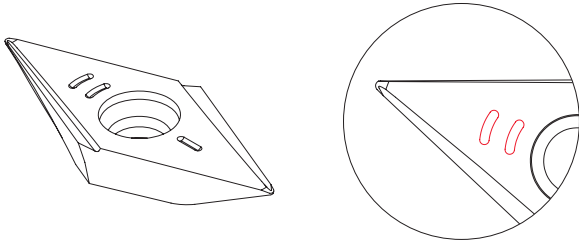

Insert Geometry

- Strong cutting edge with reinforced nose;
- Suitable for a wide range of materials;
- Easy to distinguish as chip-breaker -LM by its two marks on top of the insert.

VPGT-45LN

N

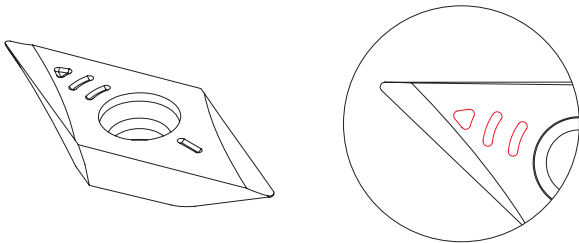

Insert Geometry

- Sharp geometry for sticky materials;
- Uncoated grade for non-ferrous materials;
- Easy to distinguish as chip-breaker -LN by its three marks on top of the insert.

TEST REPORT || Relatório de teste | Informe de prueba

Engraving CK45 Steel



Engraving AISI 316L



Cutter: 002E64067-01-10-U006040		Insert: VPGT 060202-45LM		Grade: PHH920	
Material	Strategy	n (RPM)	f (mm/min)	a _p (mm)	
CK 45	Lettering	10 000	100	0,3	
	Straight Slot	10 000	100	(1,6)	
	Curved Slot	10 000	100	(1,6)	
AIS I 316L	Lettering	10 000	100	0,3	
	Straight Slot	10 000	100	(1,6)	
	Curved Slot	10 000	100	(1,6)	

ENGRAVING 64067

NEW

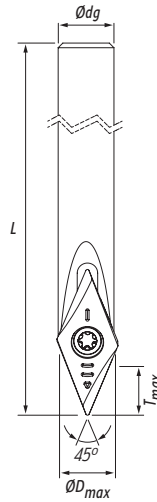

Type A: Steel Shank
Type B: Carbide Shank

Order code Código	Reference Referência Referencia	Type	Dimensions Dimensões Dimensiones (mm)								Kg	Insert Pastilha Inserto	Stock
			ØD _{min}	ØD _{max}	T _{min}	T _{max}	Ødg	L	Angle °				
181168500	002E64067-01-10-U006040	1 A	0,45~0,65	2,10	0,05~0,20	2,00	6	40	45°	0,011	VPGT 0602...	☉	
181191300	002E64067-01-10-U006065	1 B	0,45~0,65	2,10	0,05~0,20	2,00	6	65	45°	0,024	VPGT 0602...	☉	
181168700	002E64067-01-10-U006100*	1 B	0,45~0,65	2,10	0,05~0,20	2,00	6	100	45°	0,050	VPGT 0602...	☉	

Order code Código	Designation Designação Designación	Nº Toolholder	Holder designation	Nº inserts	Insert Pastilha Inserto	Stock
1410321Y3	PK VPGT 060202-45LM E64067-006040	1	002E64067-01-10-U006040	10	VPGT 060202-45LM	☉
1410322Y3	PK VPGT 060202-45LM E64067-006065	1	002E64067-01-10-U006065	10	VPGT 060202-45LM	☉
1410324Z5	PK VPGT 060202-45LN E64067-006040	1	002E64067-01-10-U006040	10	VPGT 060202-45LN	☉
1410325Z5	PK VPGT 060202-45LN E64067-006065	1	002E64067-01-10-U006065	10	VPGT 060202-45LN	☉
1410326Z5	PK VPGT 060202-45LN E64067-006100	1	002E64067-01-10-U006100*	10	VPGT 060202-45LN	☉

☉ Stock item | Produto de stock | Itens de stock

○ Available under request | Disponível sobre consulta | Disponible bajo consulta

*Note: Recommended only for non-ferrous materials machining

VPGT 0602.. | Inserts | Pastilhas | Plaquetas

VPGT-45LM

VPGT-45LN

VPGT-45LM | 45LN

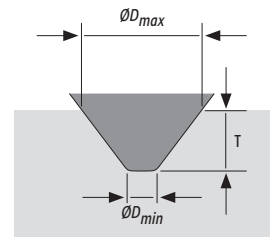
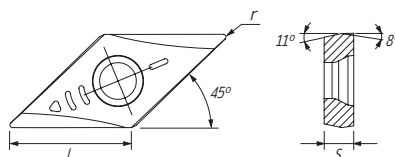
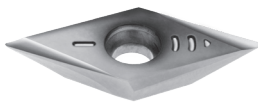
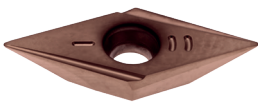

Geometry code	ISO Reference	P	M	N	S	Dimensions Dimensões Dimensiones (mm)						
		PVD	PVD	UNC	PVD	l	s	r	ØD _{min}	ØD _{max}	T _{min}	T _{max}
(2) Grade code		Y3	Y3	Z5	Y3							
(1)		PHH920	PHH920	PH0610	PHH920							
1113054	VPGT 060202-45LM	☉	☉	○	☉	6,35	2,00	0,20	0,65	2,10	0,20	2,00
1113055	VPGT 060202-45LN	○	○	☉	○	6,35	2,00	0,20	0,45	2,10	0,05	2,00

☉ First choice | Primeira opção | 1ª opción

☉ Stock item | Produto de stock | Itens de stock

○ Available under request | Disponível sobre consulta | Disponible bajo consulta

Insert order code = (1) Geometry Code + (2) Grade Code



SPARE PARTS | Complementos | Repuestos

Cutter	Insert Screw	Key (Torx)	Order separately	
			Key (Torx - Nm)	Torque Value
002E64067	P0220401	XT06	DT0606	0,6

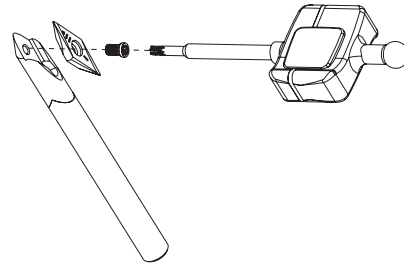

RECOMMENDED CONDITIONS | Condições recomendadas | Condiciones recomendables

ISO	Material	n (RPM)	f (mm/rev)	
			VPGT 060602-45LM	VPGT 060602-45LN
P	Carbon Steel	5 000 - 40 000	0,008 - 0,05	-
	Alloy Steel	5 000 - 40 000	0,008 - 0,03	-
M	SS - Austenitic	5 000 - 40 000	0,008 - 0,05	-
N	Aluminium and Non Ferrous	5 000 - 40 000	-	0,008 - 0,05
S	Heat Resistant Super Alloys	5 000 - 30 000	0,005 - 0,03	-

ap per step:

ISO	Material	ap (mm)							
		1st	2nd	3rd	4th	5th	6th	Next steps	Fine finishing
P	Carbon Steel	0,70	0,70	0,30	0,20	0,10	-	-	0,10
	Alloy Steel	0,50	0,40	0,30	0,30	0,20	0,20	0,10	0,10
M	SS - Austenitic	0,50	0,40	0,20	0,30	0,20	0,20	0,10	0,05
N	Aluminium and Non Ferrous	1,00	0,80	0,20	-	-	-	-	0,10
S	Heat Resistant Super Alloys	0,50	0,40	0,20	0,30	0,20	0,20	0,10	0,05

(Note 1) It is recommended to start engraving by steps according to the parameters on the table above.

(Note 2) Whenever possible, infeed should be done starting outside the workpiece being machined.

REFERENCE CHART | Gráfico de referência | Tabla de referencia

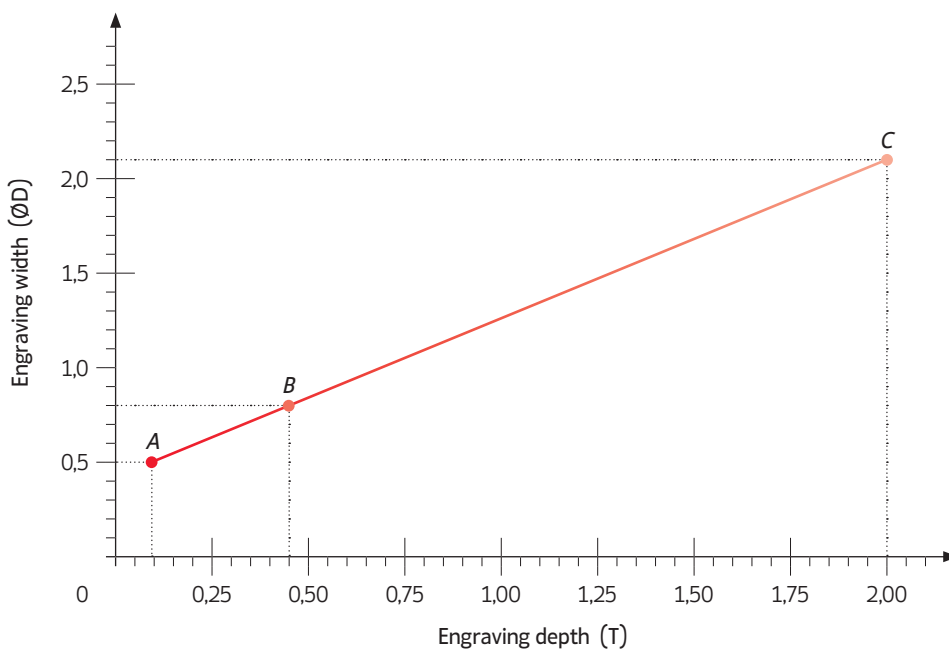

- **Point A:**
Width= 0,5 mm x Depth = 0,08 mm
- **Point B:**
Width= 0,8 mm x Depth = 0,45 mm
- **Point C:**
Width= 2,1 mm x Depth = 2,00 mm

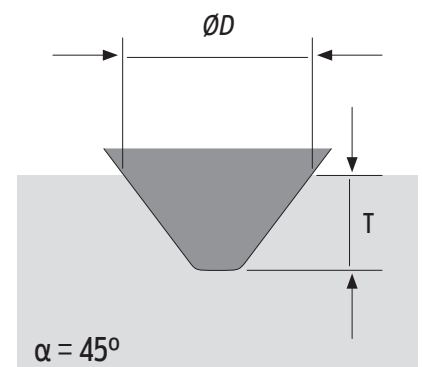

CENTER & CHAMFER

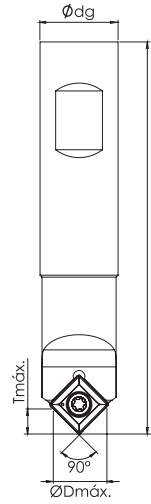

Order code Código	Reference Referência Referencia		Dimensions Dimensões Dimensiones (mm)						Kg	Insert Pastilha Inserto	Stock
			ØDmax.	Tmax.	Tmix.	Ødg	L	Angle °			
181147400	CHT S16H N11-45	1	13	6,5	1,0	16	100	45	0,146	SO..T 11T3..	
181147500	CHT S16M N11-45	1	13	6,5	1,0	16	150	45	0,180	SO..T 11T3..	

Order code Código	Designation Designação Designación	Nº Toolholder	Holder designation	Nº inserts	Insert Pastilha Inserto	Stock
1410286G4	PK SOMT 11T308 CHTS16H	1	CHT S16H N11-45	10	SOMT 11T308	
1410287G4	PK SOMT 11T308 CHTS16M	1	CHT S16M N11-45	10	SOMT 11T308	
1410317G4	PK SOGT 11T303 CHTS16M	1	CHT S16H N11-45	10	SOGT 11T303	
1410318G4	PK SOGT 11T303 CHTS16H	1	CHT S16M N11-45	10	SOGT 11T303	

Stock item | Produto de stock | Itens de stock

Available under request | Disponível sobre consulta | Disponible bajo consulta

SO...T 11T3.. | Inserts | Pastilhas | Plaquetas

SOMT

SOGT



SOMT | SOGT

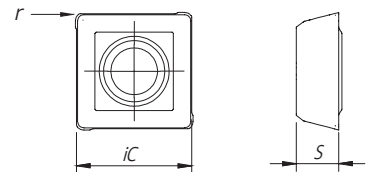

		P	M	K	Dimensions Dimensões Dimensiones (mm)			
		PVD	PVD	PVD	iC	S	l	r
⁽²⁾ Grade code		G4	G4	G4				
⁽¹⁾ Geometry code	ISO Reference	PH7920	PH7920	PH7920				
1112425	SOMT 11T308				10,87	3,97	11,00	0,80
1112973	SOGT 11T303				10,87	3,97	11,00	(0,30)

First choice | Primeira opção | 1ª opción

Stock item | Produto de stock | Itens de stock

Available under request | Disponível sobre consulta | Disponible bajo consulta

Insert order code = (1) Geometry Code + (2) Grade Code

TOOL SELECTION || Seleção de ferramenta | Selección de herramienta

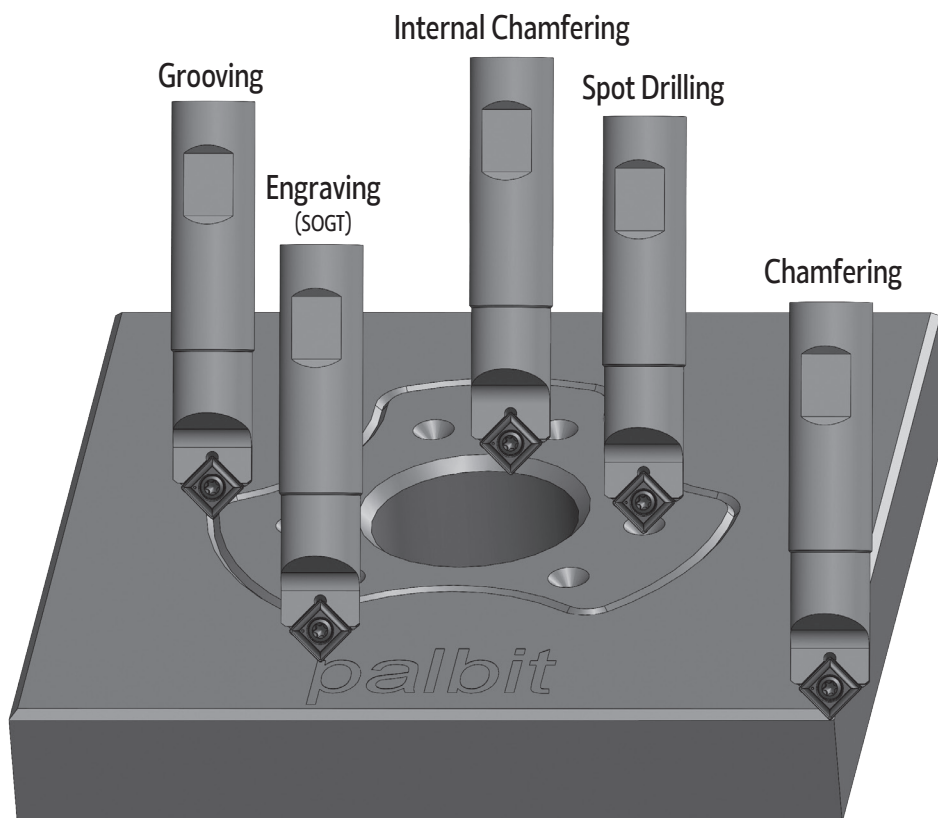

SPARE PARTS || Complementos | Repuestos

Cutter ØDc	Order separately			
	Insert Screw	Key (Torx)	Key (Torx - Nm)	Torque Value
CHT S16...	P0350800	XT15	DT1530	3,0

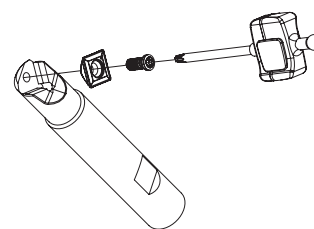

RECOMMENDED CUTTING CONDITIONS || Condições de corte recomendadas | Condiciones de corte recomendables

ISO	PSM	Material	HB (Brinell)	Vc (m/min)	Feed fz (mm/t)	
				PH7920	SOMT 11T308	SOGT 11T303
P	1	Unalloyed Steel	125-220	120-150	0,04-0,08	0,05-0,10
	2	Low-Alloyed Steel	220-280	100-120	0,03-0,07	0,05-0,10
	3	High-Alloyed Steel	280-380	60-100	0,03-0,06	0,04-0,08
M	4	SS - Ferritic / Martensitic	200-330	100-150	0,04-0,07	0,03-0,06
	5	SS - Austenitic	200-330	80-120	0,03-0,06	0,03-0,06
	6	SS - Austenitic-ferritic (Duplex)	230-260	50-90	0,03-0,06	0,03-0,08
K	7	Malleable Cast Iron	130-230	90-150	0,05-0,10	0,05-0,10
	8	Grey Cast Iron	180-245	80-120	0,05-0,08	0,05-0,08
	9	Nodular Cast iron	160-250	70-110	0,04-0,08	0,04-0,08



ENGRAVING TOOLS

NEW

HEADQUARTERS

PALBIT, S.A.

P.O.Box 4 - Palhal

3854-908 - Branca ALB - Portugal

T (+351) 234 540 300 | F (+351) 234 540 301

palbit@palbit.pt | www.palbit.pt

Branch office:

PALBIT México

Emerson 150. Int.803-804. Colonia Chapultepec

Morales Delagación Miguel Hidalgo

C.P. 11570 México DF

T (+52) 5555 454 543 | F (+52) 5552 509 190

info@palbit.com.mx | www.palbit.com.mx

Branch office:

PALBIT Brasil

Av. João XXIII, nº20 Salas 41 e 65

Vila Gilda, Sto André, SP

CEP: 09190-500 – São Paulo – Brasil

palbit@palbit.com.br | www.palbit.com.br



SINCE 1916